

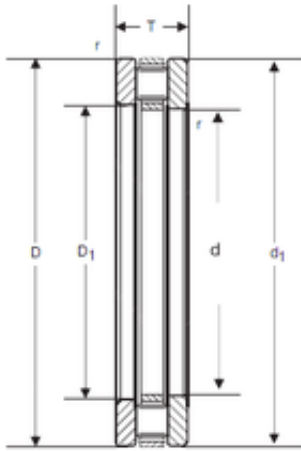

CRP Bearing & Machinery Parts Co.,...



SIGMA 81112 Rolamentos de rolos

Bearing No. 81112

Size	60x85x17 mm
Bore Diameter	60 mm
Outer Diameter	85 mm
Width	17 mm
d	60 mm
D	85 mm
T	17 mm
d1	85 mm
D1	62 mm

81112 Bearing 2D drawings and 3D CAD models